

NOTICE DE MONTAGE  
INSTRUCTIONS FOR ASSEMBLY  
MONTAGEANLEITUNG  
GEBRUIKSAANWIJZING  
ISTRUZIONI DI MONTAGGIO  
INSTRUCCIONES DE MONTAJE  
INSTRUCCOES DE MONTAGEM

**buronomic**

FABRICANT FRANÇAIS

N° DV40913

CONCEPTION ET REALISATION BUREAU D'ETUDES BURONOMIC

**GARANTEE** (vices cachés)  
\_ Référence produit à nous communiquer impérativement en cas de litige :  
Voir étiquette apposée au dos du produit

**GARANTEE** (defekt)  
\_ In the event of complaint, it is essential to mention the product reference :  
See label affixed to the back of the product.

**GARANTIE** (fabrikationfelher)  
\_ Im streitfall sit uns die produktreferenz mitzuteilen :  
Siehe etikett auf produkdruckseite.

**WAARBORG** (de verborgen gebreken)  
\_ Vermeld in geval van klachten altijd het productnummer :  
Zie label op de achterzijde van het product

**GARANZIA** (vizi occulti)  
\_ Specificare obbligatoriamente il riferimento prodotto in caso di contestazioni :  
Si veda l'etichetta applicata dietro il prodotto

**GARANTIA** (defectos ocultos)  
\_ Referencia de producto citese obligatoriamente en caso de reclamacion :  
Ver etiqueta en la parte posterior del producto.

**GARANTIA** (vícios ocultos)  
\_ Em caso de reclamacao indiqu-nos imperativamente a referência do produto :  
Ver etiqueta fixada na parte posterior do produto

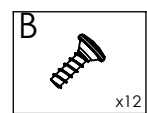
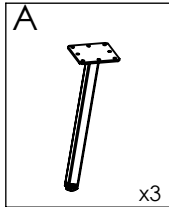
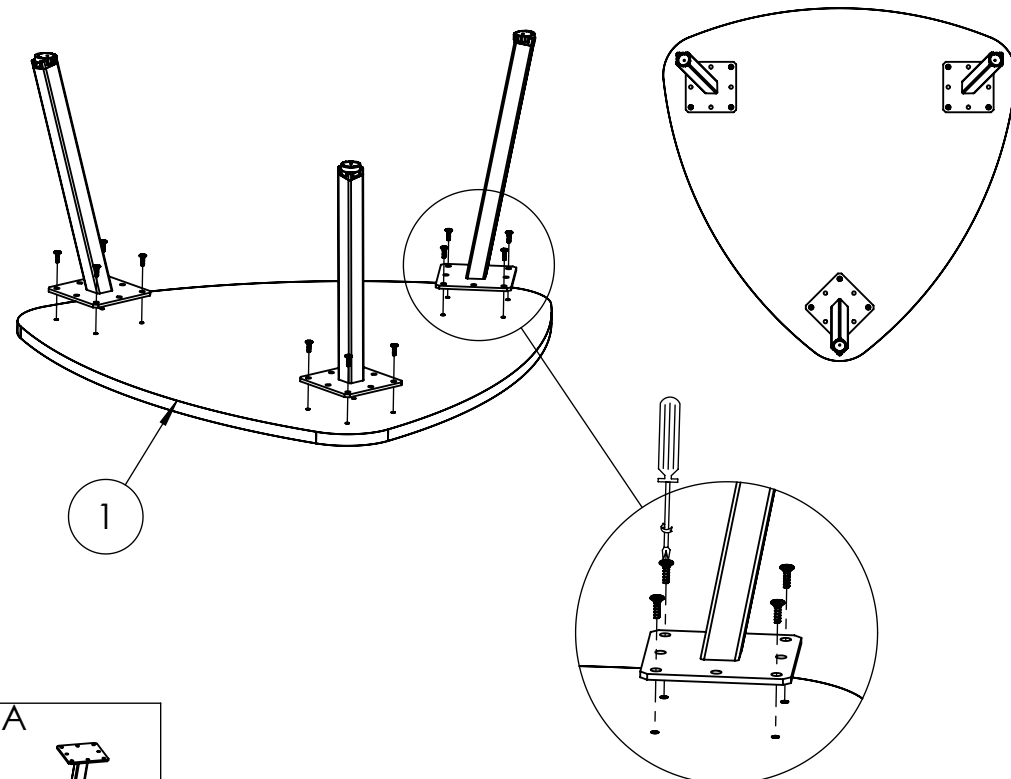

**NOMENCLATURE** (Parts list)  
(Stückliste)  
(Onderdelenlijst)  
(Nomenclatura)  
(Lista de peças)

Rep.	Pièce	Qté
1	Plan de travail	1

**QUINCAILLERIE**

Rep.	Pièce	Qté
A	Pied Table Basse	3
B	VIS Euro L 13mm	12

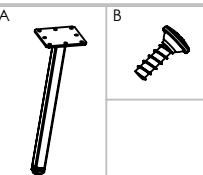

(Hardware)  
(Beschläge)  
(Ijzerwaren)  
(Ferramenta)  
(Herrajes)  
(Quinquilharia)

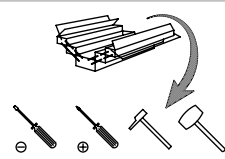
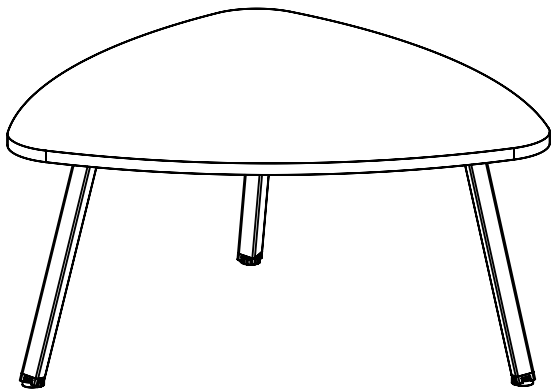

**AIDE**

HELP  
HILFE  
HULP  
AYUDA  
AJUDA  
AIUTO

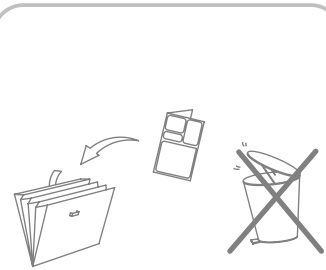
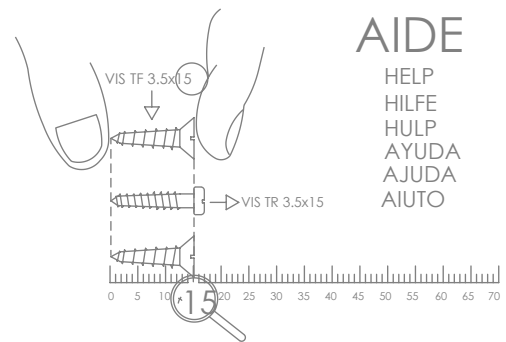

NOTICE DE MONTAGE  
INSTRUCTIONS FOR ASSEMBLY  
MONTAGEANLEITUNG  
GEBRUIKSAANWIJZING  
ISTRUZIONI DI MONTAGGIO  
INSTRUCCIONES DE MONTAJE  
INSTRUCOES DE MONTAGEM

**buromomic**

N° DV40735

CONCEPTION ET REALISATION BUREAU D'ETUDES BUROMOMIC

**GARANTIE** (vices cachés)  
\_ Référence produit à nous communiquer impérativement en cas de litige :  
Voir étiquette apposée au dos du produit

**GARANTIE** (deklagt)  
\_ In the event of complaint, it is essential to mention the product reference :  
See label affixed to the back of the product.

**GARANTIE** (fabrikationsfeil)  
\_ Im stralifall sit uns die produktreferenz mitzutellen :  
Siehe etikett auf produkttrucksella.

**WAARBORG** (de vordergen getrokken)  
\_ Vermeld in geval van klachten altijd het productnummer :  
Zie label op de achterzijde van het product

**GARANZIA** (vizi oculte)  
\_ Specificare obbligatoriamente il riferimento prodotto in caso di contestazioni :  
Si veda l'etichetta applicata dietro il prodotto

**GARANTIA** (defectos ocultos)  
\_ Referencia de producto citese obligatoriamente en caso de reclamacion :  
Ver etiqueta en la parte posterior del producto.

**GARANTIA** (vices ocultos)  
\_ Em caso de reclamaçao indiqu-nos imperativamente a referência do produto :  
Ver etiqueta fixada na parte posterior do produto

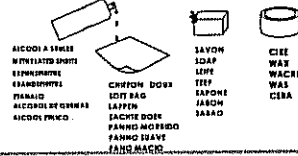
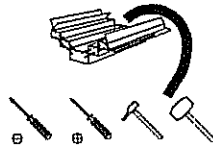
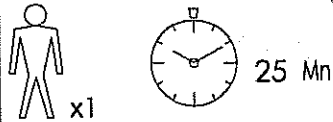
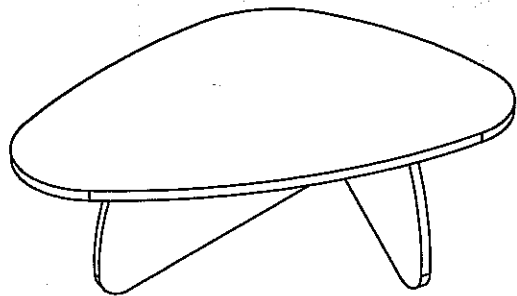

**NOMENCLATURE**

(Parts list)  
(Stückliste)  
(Onderdelenlijst)  
(Nomenclatura)  
(Lista de peças)

Rep.	Pièce	Qté
1	PLATEAU	1
2	PIED	1
3	DEMI-PIED	1

**QUINCAILLERIE**

(Hardware)  
(Beschläge)  
(Izenwaren)  
(Ferramentas)  
(Herrajes)  
(Quinquilharia)

Rep.	Pièce	Qté	A	B	C	D	E	F	G	H	I	J	K	L	M	N	O	P	Q	R
A	Goujon métal	3																		
B	Excentrique Ø15	3																		
C	Cache exent.	3																		
D	PatIn clou	3																		
E	Vis 7x70	1																		
F	Cache vis	1																		
G	Clé 6 pans 4mm	1																		

**AIDE**

HELP  
HILFE  
HULP  
AYUDA  
AJUDA  
AIUTO

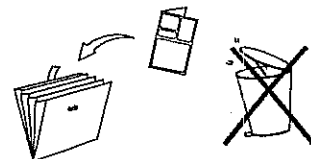
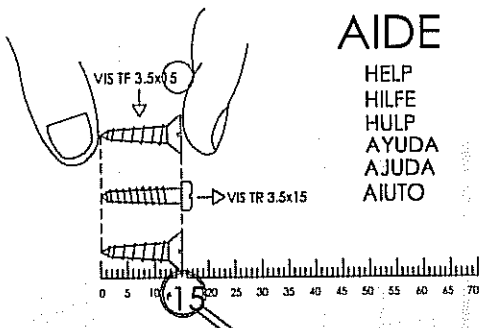

1

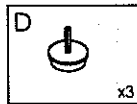
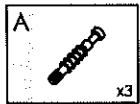
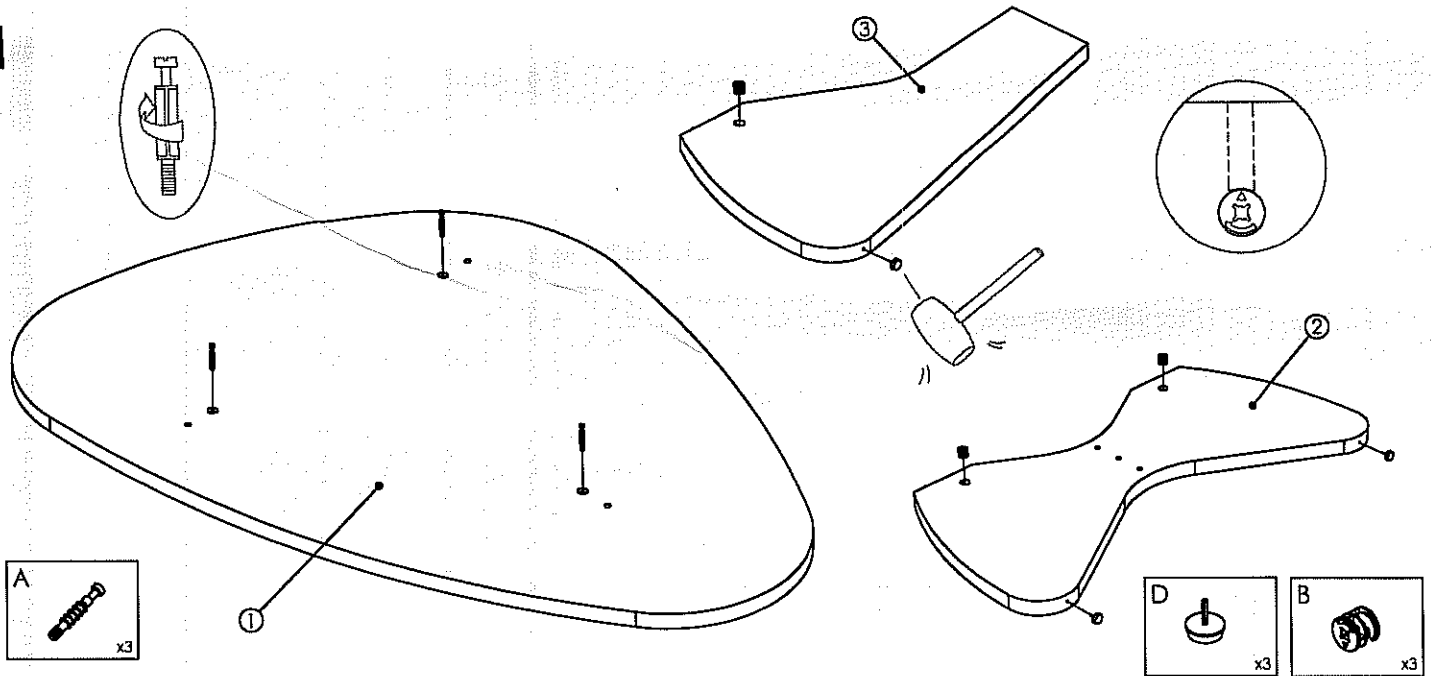

2

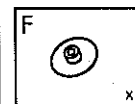
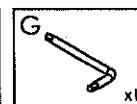
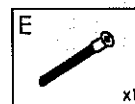
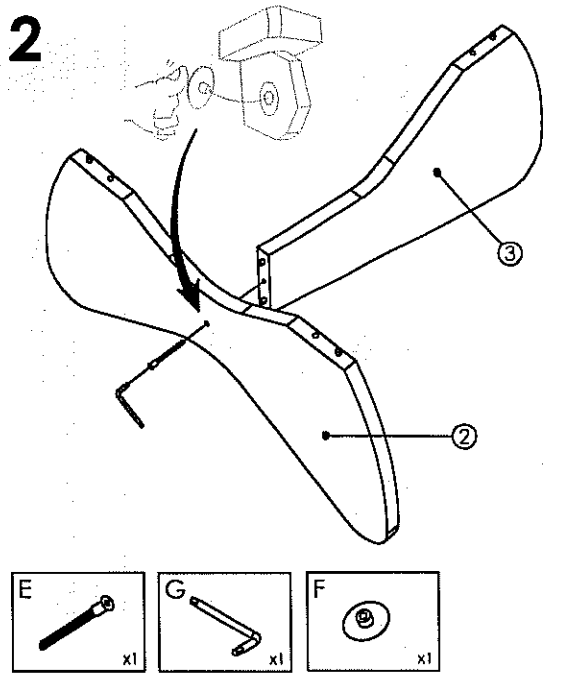

3

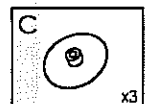
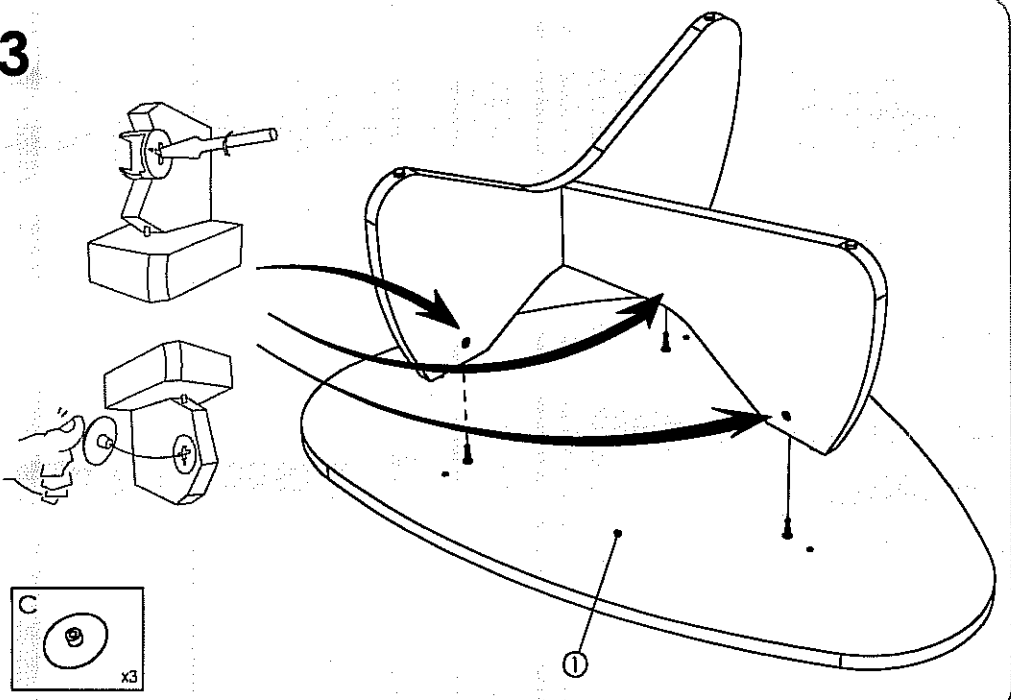

4

Option  
Optioneel  
Opzione  
Opcional  
Opção

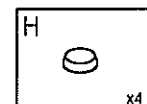

Rep.	Pièce	Qté
4	TOP VERRE LAQUE BLANC (verre trempé 8mm)	1
H	Coussinet verre	4

