

NEW



# ALTO

## Seating booths

The **Alto** seating booths blend naturally into open and modular work environments, where comfort and concentration go hand in hand. Designed to create a private environment in shared spaces, the **Alto** seating booths are equipped with surrounding acoustic partitions, perfect for discreet conversations or to simply relax. Their elegant design and their wide range of dimensions represent an ideal solution when rearranging office spaces.



# CHARACTERISTICS

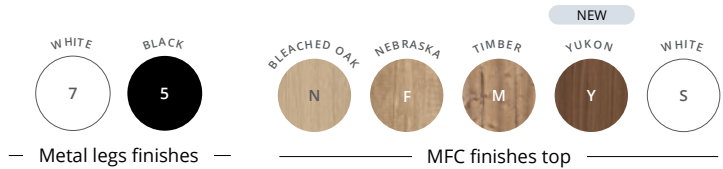

Seats, backrests and acoustic panels BeSoft fabric



Seats, backrests and acoustic panels Step Melange fabric

Alternative colour options, please contact us

## Soft seating booths - Top view

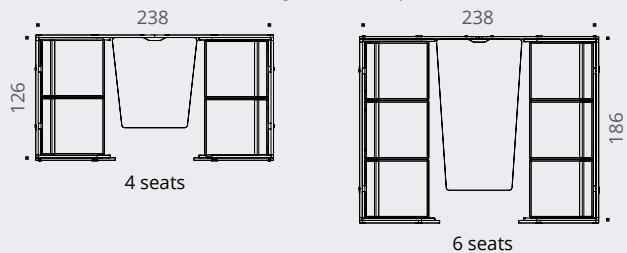

## Armchair and Settees - Top and front view

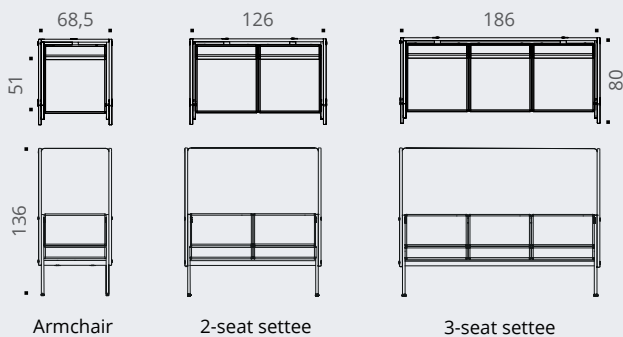

# ALTO



## Confidential panels

Upholstered acoustic panels composed of Nitech® 19 mm thick honeycomb melamine-coated panels with rounded corners (diameter 30 mm), covered in acoustic absorbing melamine foam and Step Melange fabric, 100% Trevira CS, M1 fire classification or Besoft fabric, Oeko-Tex® certified. Fixed to legs with screws and panels joined with metal connection kit.

## 4 person soft seating booth



### Top

25 mm thick Structurex® melamine panel. 2 mm thick shock-proof ABS edging. Top with a cut-out for cable management and installation of a monitor arm. Fixed with brackets to the confidential panels. Square 50 x 50 mm leg cross-section.

## Structure

Seat structures connected by steel structural beams, cross-section 40 x 25 mm, with lacquered epoxy finish. Seat and back supports made of 16 mm thick melamine-coated panel. Assembled with screws.

## Legs

Metal arch leg, square cross-section 25 x 25 mm, with adjustable screw feet (Ø 25 mm and range 15 mm).

## Seats and back backrests

Seats with PE foam padding, density 40 kg/m³, attached by Velcro strips. Backrests with PE foam padding, density 30 kg/m³, attached with magnets. Upholstered with Step Melange fabric, 100% Trevira CS, M1 Fire classification or Besoft fabric, certified Oeko-Tex®. Fixed to legs with screws.



Confidential armchair



Confidential 2-seat settee



Confidential 3-seat settee

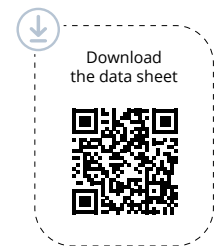



— Metal legs finishes —



## SEATING BOOTHS

	Ref.	Leg finish	Fabric seat and backrest finish	Fabric acoustic panels finish
<b>Armchair</b> D 80 / H 136 / L 68,5 cm Seat : D 50 / H 47 / L 57 cm 	EG05	+ [ ]	+ [ ]	+ [ ]
<b>2-seat settee</b> D 80 / H 136 / L 126 cm Seat : D 50 / H 47 / L 115 cm 	EG06	+ [ ]	+ [ ]	+ [ ]
<b>3-seat settee</b> D 80 / H 136 / L 186 cm Seat : D 50 / H 47 / L 175 cm 	EG07	+ [ ]	+ [ ]	+ [ ]

Colour matching only between fabrics of the same category



► **Option**

	Dim. (cm)	Ref.	Leg finish	Top finish
<b>Low table</b> 3 metal legs 	D 70 / H 34 / L 70	DY36	+ [ ]	+ [ ]

How to order ? Alto 3-seat settee L 186 cm, **Black** legs finish, **Sea Green** Step Melange seat and backrest fabric, **Petrol Blue** acoustic panels fabric = EG07 + [ 5 | C | J ]



ALTO 



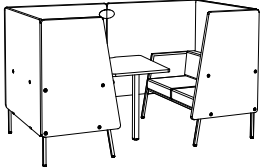
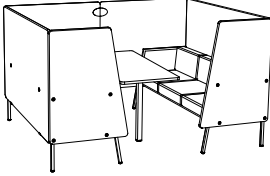

NEW

## SOFT SEATING BOOTHS

	Ref.	Leg finish	Top finish	Fabric seat and backrest finish	Fabric acoustic panels finish
<b>4 persons soft seating booth</b> D 126 / H 136 / L 238 cm Seat : D 51 / H 46 / L 115 cm 	EG72	+ <input type="checkbox"/>	+ <input type="checkbox"/>	+ <input type="checkbox"/>	+ <input type="checkbox"/>
<b>6 persons soft seating booth</b> D 186 / H 136 / L 238 cm Seat : D 51 / H 46 / L 175 cm 	EG73	+ <input type="checkbox"/>	+ <input type="checkbox"/>	+ <input type="checkbox"/>	+ <input type="checkbox"/>

Colour matching only between fabrics of the same category

### ► Options

	Description	Dim. (cm)	Ref.	Finish
<b>Support arm for 1 screen</b> <b>Single extension arm</b> For 1 screen up to 27" (7 kg max) Equipped with a built-in cable cover 	Gas spring for smooth and precise adjustment Maximum weight 7 kg	D 27 / L 12,5 / H 28 Offset 28,3	DL06	+ <input type="checkbox"/>
<b>UK portable power module</b> Equipped with 1 PC + 1 USB A 5v + 1 USB C 5v with 2 m power supply cable 	Attaches under the seat with wood screws	D 7 / L 12 / H 6 - 14	EF997S EF995G	<input type="radio"/> White <input type="radio"/> Black

**How to order ?** Alto 4 person soft seating booth, **Black** legs, **Nebraska** top MFC finish, BeSoft **Sand** fabric backrests and seat cushions, BeSoft **Chocolate** fabric acoustic panels = EG72 +  **5** |  **F** |  **D** |  **Y** |