

## ASTROLITE

The design of Astrolite blends harmoniously into every working environment.

Whether single or multi-workstation configuration in open-space layout, **Astrolite** modular desks are the ideal solution to adjust to the changing needs of companies with limited budgets. **Astrolite** offers the modular components you need to adapt workstations to suit employee working habits.





**Single desk on B-box console**  
White - Nebraska

**Video : How to create an opening  
in part drilled tops ?**

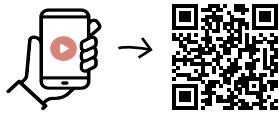

Scan the QR Code

# ASTROLITE

**Multi-workstations  
with Tower pedestals**  
Black - White



COLLABORATIVE DESKS

# ASTROLITE



## Top

25 mm thick Structorex® melamine-coated panel. 2 mm thick shock-proof ABS edging.

In back-to-back configuration, a 3 cm gap is provided between the tops for a screen divider or to feed cables.

## Adjustment

Adjustable screw feet of Ø 40 mm and range 10 mm to compensate for any unevenness in the floor.

## Leg

Metal arch legs, square cross-section 50 x 50 mm. The assembly is connected by a central steel beam with lacquered epoxy finish. In multi-workstation version, the legs on add-on units are recessed to move easily from one desk to another. Fixed (H 72 cm) or height-adjustable (66,5 cm to 88,5 cm) arch legs for single workstations (page 80).

## Single desk



## Multi-workstation



## Electrification

Tops fitted with part drilled cable ports, **Ø 80 mm cable ports**, a single Top Access hatch (internal dimensions L 30,9 / D 11,6 cm) finishes matching the legs or a 3 cm deep scallop to feed cables, depending on version.

Available in sliding top version (with scalloped edge) for easy access to the cables and the electrical connections.

## CHARACTERISTICS



Metal legs finishes

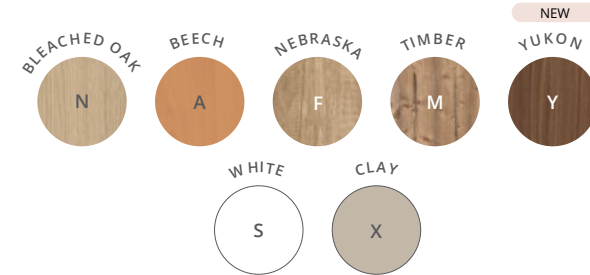

Tops and B-box console MFC finishes

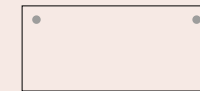

Tops with cable ports (D 70 / D 80 cm)



Tops with scalloped edge (D 70 / D 80 cm)



Tops with Top Access hatch (only D 80 cm)

Available with part drilled cable ports (only D 80 cm)

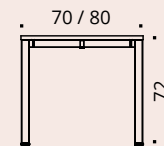

Arch leg

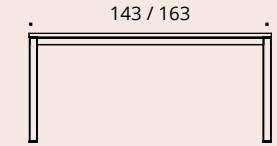

Multi-workstation arch leg

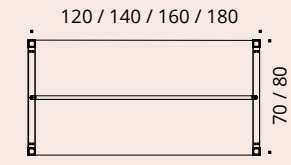

Desk - bottom view

## B-box

Single desks or multi-workstations available with the B-box return console (dim. L 140 / D 55 / H 59,5 cm).

Positioned to the right or left of the desks, B-box is made up of 2 compartments L 67,5 / D 49,5 cm equipped with an adjustable shelf.

Sliding pen tray available as an option. 2 handle models available.

## Single desk on B-box console



Download the data sheet

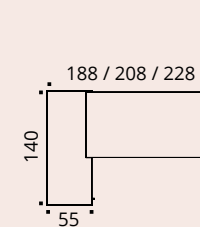

Single desk on B-box console top view

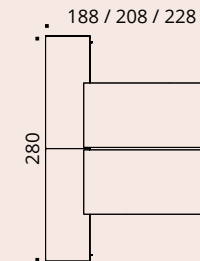

Multi-workstation on B-box console top view

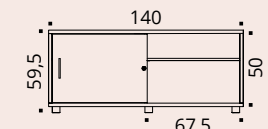

B-box console front view

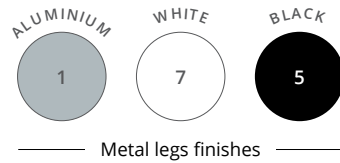

ASTROLITE



## SINGLE DESKS without cable port



|   | Dim. (cm) | Ref. | Leg finish                 | Top finish                 |
|---|-----------|------|----------------------------|----------------------------|
| <b>Straight desks</b><br>H 72 cm<br> | L 120     | DE76 | + <input type="checkbox"/> | + <input type="checkbox"/> |
|   | L 140     | DE77 | + <input type="checkbox"/> | + <input type="checkbox"/> |
|   | L 160     | DE78 | + <input type="checkbox"/> | + <input type="checkbox"/> |
|   | L 180     | DW20 | + <input type="checkbox"/> | + <input type="checkbox"/> |

Tops come with 2 Ø 80 mm part drilled cable ports

|   | Dim. (cm)    | Ref. | Leg finish                 | Top finish                 |
|---|--------------|------|----------------------------|----------------------------|
| <b>Extension / Return</b><br>On support leg<br>H 72 cm<br> | D 60 / L 80  | BU50 | + <input type="checkbox"/> | + <input type="checkbox"/> |
|   | D 60 / L 100 | DZ11 | + <input type="checkbox"/> | + <input type="checkbox"/> |

### ► Options

**Technical metal cable trays**  
D 16 / H 8 cm  
Internal H 4 cm

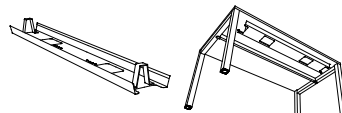

Dim. (cm)

L 90 for L 120 desk  
L 110 for L 140 desk  
L 130 for L 160 desk  
L 150 for L 180 desk

ALUMINIUM     WHITE     BLACK

Ref.                      Ref.                      Ref.

|        |        |        |
|--------|--------|--------|
| AZ201K | AZ207S | AZ205G |
| AZ211K | AZ217S | AZ215G |
| AZ221K | AZ227S | AZ225G |
| AZ231K | AZ237S | AZ235G |

**UK cable port power module**  
UK power socket + 1 USB A socket  
5v + 1 USB C socket 5v  
With a 2 m power supply cable

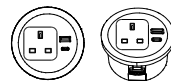

Ø 91 mm  
Fitted into the Ø 80 mm  
cable port of desk

—                      DX877S                      DX875G



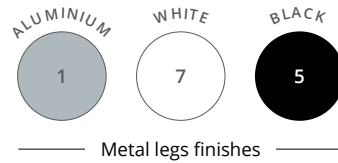

\* for door and fittings B-box

## SINGLE DESKS with cable ports

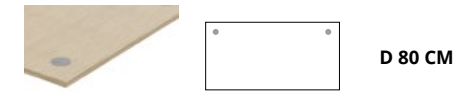
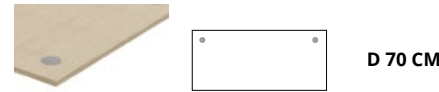

|   | Dim. (cm)               | Ref. | Leg finish | Top finish | Ref. | Leg finish | Top finish |
|---|-------------------------|------|------------|------------|------|------------|------------|
| <b>Straight desks</b><br>H 72 cm                                | L 120                   | BT37 | +          | +          | BK42 | +          | +          |
|   | L 140                   | BT38 | +          | +          | BK43 | +          | +          |
|   | L 160                   | BT39 | +          | +          | BK44 | +          | +          |
|   | L 180                   | —    | —          | —          | BK45 | +          | +          |
|   | L 143                   | BT40 | +          | +          | EG75 | +          | +          |
|   | L 163                   | BT41 | +          | +          | EG76 | +          | +          |
| <b>Compact desks</b><br>D 80 to 110 / H 72 cm<br>D 60 cm return | L 160 right hand return | BT44 | +          | +          |      |            |            |
|   | L 160 left hand return  | BT45 | +          | +          |      |            |            |
|   | L 180 right hand return | BT46 | +          | +          |      |            |            |
|   | L 180 left hand return  | BT47 | +          | +          |      |            |            |
|   |                         |      |            |            |      |            |            |
| <b>Extension / Return</b><br>On support leg<br>H 72 cm          | D 60 / L 80             | BU50 | +          | +          |      |            |            |
|   | D 60 / L 100            | DZ11 | +          | +          |      |            |            |

## SINGLE DESKS with cable ports on B-box console

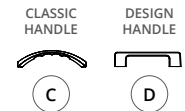

|   | Main station dim. (cm) | Total dim. (cm) | Ref. | Leg finish | Top and B-box structure finish | Door and fittings B-box finish | Handle type |
|---|------------------------|-----------------|------|------------|--------------------------------|--------------------------------|-------------|
| <b>Straight desks D 80 / H 72 cm on B-box console</b><br>The B-box console can be positioned on the right or the left | D 80 / L 140           | D 140 / L 188   | EB17 | +          | +                              | +                              | +           |
|   | D 80 / L 160           | D 140 / L 208   | EB18 | +          | +                              | +                              | +           |
|   | D 80 / L 180           | D 140 / L 228   | EB19 | +          | +                              | +                              | +           |

Cable port covers and handle finish matches the legs - Handle model to be specified (C or D)

How to order? Straight desk D 80 / L 160 cm on B-box console,

White metal leg, Nebraska top and B-box structure MFC finish, White door and fittings B-box MFC finish, type D handle = EB18 + 7 | F | S | D

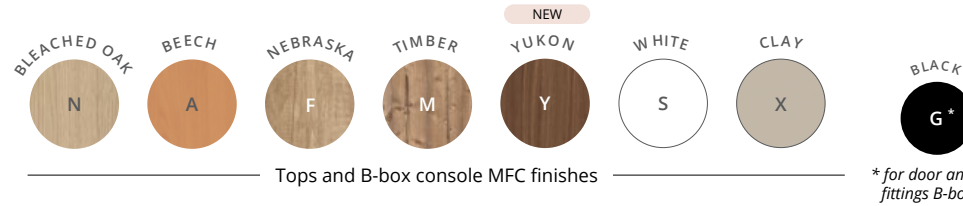
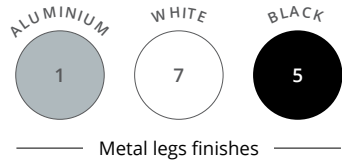

ASTROLITE



## SINGLE DESKS with scalloped edge



|                                  | Dim. (cm) | Ref. | Leg finish                 | Top finish                 | Ref. | Leg finish                 | Top finish                 |
|----------------------------------|-----------|------|----------------------------|----------------------------|------|----------------------------|----------------------------|
| <b>Straight desks</b><br>H 72 cm | L 120     | DP46 | + <input type="checkbox"/> | + <input type="checkbox"/> | DP49 | + <input type="checkbox"/> | + <input type="checkbox"/> |
|                                  | L 140     | DP47 | + <input type="checkbox"/> | + <input type="checkbox"/> | DP50 | + <input type="checkbox"/> | + <input type="checkbox"/> |
|                                  | L 160     | DP48 | + <input type="checkbox"/> | + <input type="checkbox"/> | DP51 | + <input type="checkbox"/> | + <input type="checkbox"/> |
|                                  | L 180     | —    | —                          | —                          | DP52 | + <input type="checkbox"/> | + <input type="checkbox"/> |
|                                  | L 143     | EB57 | + <input type="checkbox"/> | + <input type="checkbox"/> | EG77 | + <input type="checkbox"/> | + <input type="checkbox"/> |
|                                  | L 163     | EB58 | + <input type="checkbox"/> | + <input type="checkbox"/> | EG78 | + <input type="checkbox"/> | + <input type="checkbox"/> |

|  | Dim. (cm)    | Ref. | Leg finish                 | Top finish                 |
|--|--------------|------|----------------------------|----------------------------|
| <b>Extension / Return</b><br>On support leg<br>H 72 cm | D 60 / L 80  | BU50 | + <input type="checkbox"/> | + <input type="checkbox"/> |
|  | D 60 / L 100 | DZ11 | + <input type="checkbox"/> | + <input type="checkbox"/> |

## SINGLE DESKS with scalloped edge on B-box console

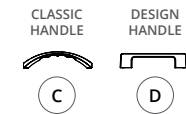

|   | Main station dim. (cm) | Total dim. (cm) | Ref. | Leg finish                 | Top and B-box structure finish | Door and fittings B-box finish | Handle type                |
|---|------------------------|-----------------|------|----------------------------|--------------------------------|--------------------------------|----------------------------|
| <b>Straight desks D 80 / H 72 cm on B-box console</b><br>The B-box console can be positioned on the right or the left | D 80 / L 140           | D 140 / L 188   | EB20 | + <input type="checkbox"/> | + <input type="checkbox"/>     | + <input type="checkbox"/>     | + <input type="checkbox"/> |
|   | D 80 / L 160           | D 140 / L 208   | EB21 | + <input type="checkbox"/> | + <input type="checkbox"/>     | + <input type="checkbox"/>     | + <input type="checkbox"/> |
|   | D 80 / L 180           | D 140 / L 228   | EB22 | + <input type="checkbox"/> | + <input type="checkbox"/>     | + <input type="checkbox"/>     | + <input type="checkbox"/> |

Handle finish matches the legs - Handle model to be specified (C or D)

### ► Options

**Technical metal cable trays**  
D 16 / H 8 cm  
Internal H 4 cm

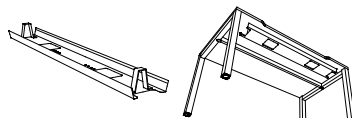

| Dim. (cm)            | ALUMINIUM | WHITE  | BLACK  |
|----------------------|-----------|--------|--------|
|                      | Ref.      | Ref.   | Ref.   |
| L 90 for L 120 desk  | AZ201K    | AZ207S | AZ205G |
| L 110 for L 140 desk | AZ211K    | AZ217S | AZ215G |
| L 130 for L 160 desk | AZ221K    | AZ227S | AZ225G |
| L 150 for L 180 desk | AZ231K    | AZ237S | AZ235G |



How to order ? Straight desk D 80 / L 160 cm with scalloped edge, **Black** metal leg, **Clay** top MFC finish = DP51 +  5  X

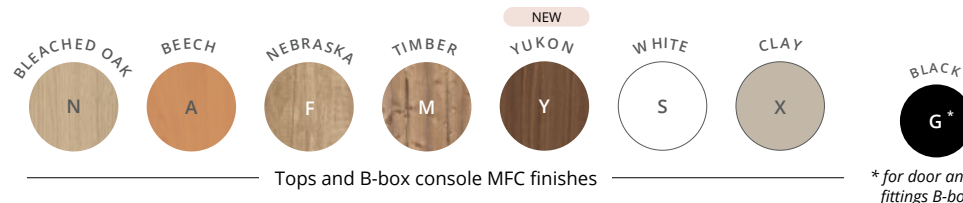
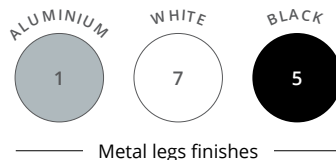

\* for door and fittings B-box

## SINGLE DESKS with Top Access hatch



|                                  | Dim. (cm) | Ref. | Leg finish                 | Top finish                 |
|----------------------------------|-----------|------|----------------------------|----------------------------|
| <b>Straight desks</b><br>H 72 cm | L 120     | DE85 | + <input type="checkbox"/> | + <input type="checkbox"/> |
|                                  | L 140     | DE86 | + <input type="checkbox"/> | + <input type="checkbox"/> |
|                                  | L 160     | DE87 | + <input type="checkbox"/> | + <input type="checkbox"/> |
|                                  | L 180     | DE88 | + <input type="checkbox"/> | + <input type="checkbox"/> |

|  | Dim. (cm)    | Ref. | Leg finish                 | Top finish                 |
|--|--------------|------|----------------------------|----------------------------|
| <b>Extension / Return</b><br>On support leg<br>H 72 cm | D 60 / L 80  | BU50 | + <input type="checkbox"/> | + <input type="checkbox"/> |
|  | D 60 / L 100 | DZ11 | + <input type="checkbox"/> | + <input type="checkbox"/> |

## SINGLE DESKS with Top Access hatch on B-box console

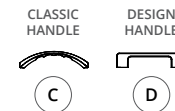

|   | Main station dim. (cm) | Total dim. (cm) | Ref. | Leg finish                 | Top and B-box structure finish | Door and fittings B-box finish | Handle type                |
|---|------------------------|-----------------|------|----------------------------|--------------------------------|--------------------------------|----------------------------|
| <b>Straight desks D 80 / H 72 cm on B-box console</b><br>The B-box console can be positioned on the right or the left | D 80 / L 140           | D 140 / L 188   | EB23 | + <input type="checkbox"/> | + <input type="checkbox"/>     | + <input type="checkbox"/>     | + <input type="checkbox"/> |
|   | D 80 / L 160           | D 140 / L 208   | EB24 | + <input type="checkbox"/> | + <input type="checkbox"/>     | + <input type="checkbox"/>     | + <input type="checkbox"/> |
|   | D 80 / L 180           | D 140 / L 228   | EB25 | + <input type="checkbox"/> | + <input type="checkbox"/>     | + <input type="checkbox"/>     | + <input type="checkbox"/> |

Top Access hatch and handle finish matches the legs - Handle model to be specified (C or D)

### Options

|  | Dim. (cm)            | ALUMINIUM Ref. | WHITE Ref. | BLACK Ref. |
|--|----------------------|----------------|------------|------------|
| <b>Technical metal cable trays</b><br>D 16 / H 8 cm<br>Internal H 4 cm | L 90 for L 120 desk  | AZ201K         | AZ207S     | AZ205G     |
|  | L 110 for L 140 desk | AZ211K         | AZ217S     | AZ215G     |
|  | L 130 for L 160 desk | AZ221K         | AZ227S     | AZ225G     |
|  | L 150 for L 180 desk | AZ231K         | AZ237S     | AZ235G     |



# ASTROLITE | MULTI-WORKSTATIONS

Multi-workstation with Tower pedestal and Top box  
White - Timber



Multi-workstations  
White - Bleached Oak

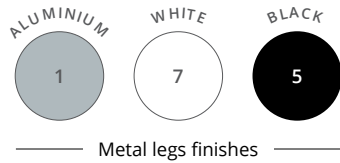

ASTROLITE



## MULTI-WORKSTATIONS without cable port

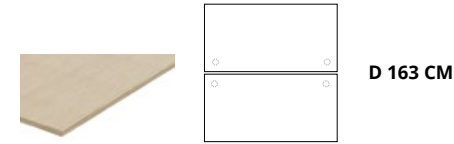

|   |  | Dim. (cm) | Ref. | Leg finish | Top finish |
|---|--|-----------|------|------------|------------|
| <b>2 back to back desks</b><br><b>Starter unit</b><br>H 72 cm |  | L 120     | DE79 | +          | +          |
|   |  | L 140     | DE80 | +          | +          |
|   |  | L 160     | DE81 | +          | +          |
|   |  | L 180     | DW21 | +          | +          |
| <b>2 back to back desks</b><br><b>Add-on unit</b><br>H 72 cm  |  | L 120     | DE61 | +          | +          |
|   |  | L 140     | DE62 | +          | +          |
|   |  | L 160     | DE63 | +          | +          |
|   |  | L 180     | DW05 | +          | +          |

Tops come with 2 Ø 80 mm part drilled cable ports

### ► Options

|   |  | Dim. (cm)            | Ref.   | <b>BLACK</b> |
|---|--|----------------------|--------|--------------|
| <b>Double metal cable trays</b><br>D 33,5 / H 9 cm<br>Internal H 4,5 cm |  | L 75 for L 120 desk  | DZ135G |              |
|   |  | L 95 for L 140 desk  | DW765G |              |
|   |  | L 115 for L 160 desk | DW775G |              |
|   |  | L 135 for L 180 desk | DW785G |              |

|  | Description   | Ref.   | Finish |
|--|---|--------|--------|
| <b>UK cable port power module</b><br>UK power socket + 1 USB A socket 5v<br>+ 1 USB C socket 5v<br>With a 2 m power supply cable | Ø 91 mm<br>Fitted into the Ø 80 mm cable port of desk | DX875G | Black  |
|  |   | DX877S | White  |

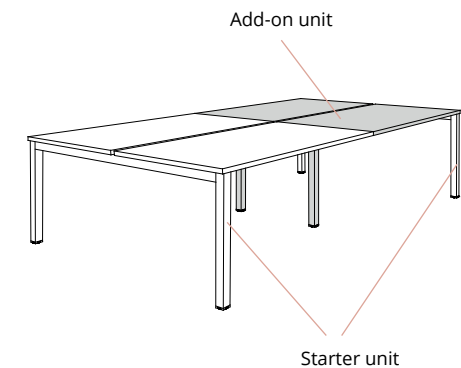

COLLABORATIVE DESKS



Metal legs finishes



Tops and B-box console MFC finishes

\* for door and fittings B-box

## MULTI-WORKSTATIONS

with cable ports

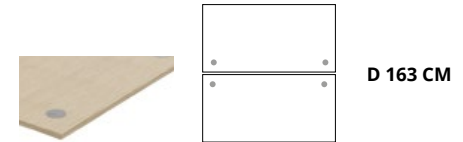
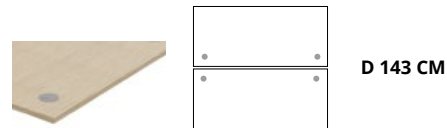

|   |  | Dim. (cm) | Ref. | Leg finish | Top finish | Ref. | Leg finish | Top finish |
|---|--|-----------|------|------------|------------|------|------------|------------|
| <b>2 back to back desks Starter unit</b><br>H 72 cm |  | L 120     | BT53 | + [ ]      | + [ ]      | BK52 | + [ ]      | + [ ]      |
|   |  | L 140     | BT54 | + [ ]      | + [ ]      | BK53 | + [ ]      | + [ ]      |
|   |  | L 160     | BT55 | + [ ]      | + [ ]      | BK54 | + [ ]      | + [ ]      |
|   |  | L 180     | —    | —          | —          | BK55 | + [ ]      | + [ ]      |
| <b>2 back to back desks Add-on unit</b><br>H 72 cm  |  | L 120     | BT56 | + [ ]      | + [ ]      | BK56 | + [ ]      | + [ ]      |
|   |  | L 140     | BT57 | + [ ]      | + [ ]      | BK57 | + [ ]      | + [ ]      |
|   |  | L 160     | BT58 | + [ ]      | + [ ]      | BK58 | + [ ]      | + [ ]      |
|   |  | L 180     | —    | —          | —          | BK59 | + [ ]      | + [ ]      |

## MULTI-WORKSTATIONS

with cable ports on B-box consoles

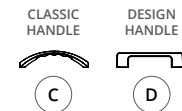

|  |  | Main station dim. (cm) | Total dim. (cm) | Ref. | Leg finish | Top and B-box structure finish | Door and fittings B-box finish | Handle type |
|--|--|------------------------|-----------------|------|------------|--------------------------------|--------------------------------|-------------|
| <b>2 back to back desks D 80 cm on 2 B-box consoles</b><br>H 72 cm |  | D 163 / L 140          | D 280 / L 188   | EB26 | + [ ]      | + [ ]                          | + [ ]                          | + [ ]       |
|  |  | D 163 / L 160          | D 280 / L 208   | EB27 | + [ ]      | + [ ]                          | + [ ]                          | + [ ]       |
|  |  | D 163 / L 180          | D 280 / L 228   | EB28 | + [ ]      | + [ ]                          | + [ ]                          | + [ ]       |

Cable port covers and handles finish matches the legs - Handle model to be specified (C or D)

### Options

**Double metal cable trays**  
D 33,5 / H 9 cm  
Internal H 4,5 cm

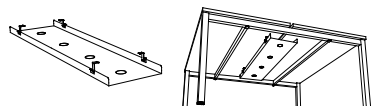

Dim. (cm)

● BLACK

Ref.

L 75 for L 120 desk  
L 95 for L 140 desk  
L 115 for L 160 desk  
L 135 for L 180 desk

DZ135G  
DW765G  
DW775G  
DW785G



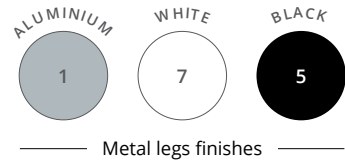

ASTROLITE



## MULTI-WORKSTATIONS with scalloped edge

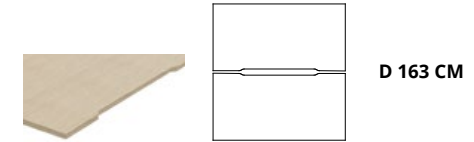
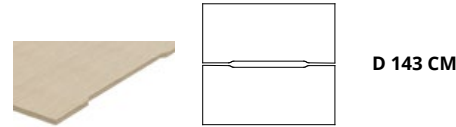

|   |  | Dim. (cm) | Ref. | Leg finish | Top finish | Ref. | Leg finish | Top finish |
|---|--|-----------|------|------------|------------|------|------------|------------|
| <b>2 back to back desks<br/>Starter unit</b><br>H 72 cm |  | L 120     | BT59 | + [ ]      | + [ ]      | DH48 | + [ ]      | + [ ]      |
|   |  | L 140     | BT60 | + [ ]      | + [ ]      | BR52 | + [ ]      | + [ ]      |
|   |  | L 160     | BT61 | + [ ]      | + [ ]      | BR53 | + [ ]      | + [ ]      |
|   |  | L 180     | —    | —          | —          | BR54 | + [ ]      | + [ ]      |
| <b>2 back to back desks<br/>Add-on unit</b><br>H 72 cm  |  | L 120     | BT62 | + [ ]      | + [ ]      | DH47 | + [ ]      | + [ ]      |
|   |  | L 140     | BT63 | + [ ]      | + [ ]      | BR56 | + [ ]      | + [ ]      |
|   |  | L 160     | BT64 | + [ ]      | + [ ]      | BR57 | + [ ]      | + [ ]      |
|   |  | L 180     | —    | —          | —          | BR58 | + [ ]      | + [ ]      |

## MULTI-WORKSTATIONS with scalloped edge on B-box consoles

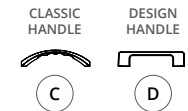

|  |  | Main station dim. (cm) | Total dim. (cm) | Ref. | Leg finish | Top and B-box structure finish | Door and fittings B-box finish | Handle type |
|--|--|------------------------|-----------------|------|------------|--------------------------------|--------------------------------|-------------|
| <b>2 back to back desks D 80 cm<br/>on 2 B-box consoles</b><br>H 72 cm |  | D 163 / L 140          | D 280 / L 188   | EB29 | + [ ]      | + [ ]                          | + [ ]                          | + [ ]       |
|  |  | D 163 / L 160          | D 280 / L 208   | EB30 | + [ ]      | + [ ]                          | + [ ]                          | + [ ]       |
|  |  | D 163 / L 180          | D 280 / L 228   | EB31 | + [ ]      | + [ ]                          | + [ ]                          | + [ ]       |

Handles finish matches the legs - Handle model to be specified (C or D)

### ► B-box option

|                         | Ref.   | Finish |
|-------------------------|--------|--------|
| <b>Sliding pen tray</b> | BF901K | Grey   |

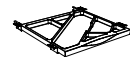

How to order ? 2 back to back desks with scalloped edge D 163 / L 140 cm, starter unit, **White** metal leg, **Bleached Oak** top MFC finish = BR52 + [ 7 ] [ N ]

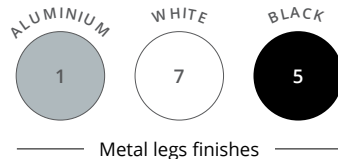

\* for door and fittings B-box

## MULTI-WORKSTATIONS with Top Access hatch

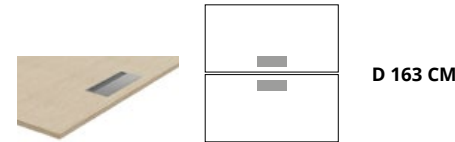

|   |  | Dim. (cm) | Ref. | Leg finish                 | Top finish                 |
|---|--|-----------|------|----------------------------|----------------------------|
| <b>2 back to back desks<br/>Starter unit</b><br>D 163 / H 72 cm |  | L 120     | DE89 | + <input type="checkbox"/> | + <input type="checkbox"/> |
|   |  | L 140     | DE90 | + <input type="checkbox"/> | + <input type="checkbox"/> |
|   |  | L 160     | DE91 | + <input type="checkbox"/> | + <input type="checkbox"/> |
|   |  | L 180     | DE92 | + <input type="checkbox"/> | + <input type="checkbox"/> |
| <b>2 back to back desks<br/>Add-on unit</b><br>D 163 / H 72 cm  |  | L 120     | DE72 | + <input type="checkbox"/> | + <input type="checkbox"/> |
|   |  | L 140     | DE73 | + <input type="checkbox"/> | + <input type="checkbox"/> |
|   |  | L 160     | DE74 | + <input type="checkbox"/> | + <input type="checkbox"/> |
|   |  | L 180     | DE75 | + <input type="checkbox"/> | + <input type="checkbox"/> |

## MULTI-WORKSTATIONS with Top Access hatch on B-box consoles

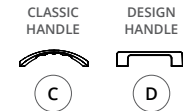

|  |  | Main station dim. (cm) | Total dim. (cm) | Ref. | Leg finish                 | Top and B-box structure finish | Door and fittings B-box finish | Handle type                |
|--|--|------------------------|-----------------|------|----------------------------|--------------------------------|--------------------------------|----------------------------|
| <b>2 back to back desks D 80 cm<br/>on 2 B-box consoles</b><br>H 72 cm |  | D 163 / L 140          | D 280 / L 188   | EB32 | + <input type="checkbox"/> | + <input type="checkbox"/>     | + <input type="checkbox"/>     | + <input type="checkbox"/> |
|  |  | D 163 / L 160          | D 280 / L 208   | EB33 | + <input type="checkbox"/> | + <input type="checkbox"/>     | + <input type="checkbox"/>     | + <input type="checkbox"/> |
|  |  | D 163 / L 180          | D 280 / L 228   | EB34 | + <input type="checkbox"/> | + <input type="checkbox"/>     | + <input type="checkbox"/>     | + <input type="checkbox"/> |

Top Access hatch and handles finish matches the legs - Handle model to be specified (C or D)

### Options

|   |  | Dim. (cm)            | Ref.   |
|---|--|----------------------|--------|
| <b>Double metal cable trays</b><br>D 33,5 / H 9 cm<br>Internal H 4,5 cm |  | L 75 for L 120 desk  | DZ135G |
|   |  | L 95 for L 140 desk  | DW765G |
|   |  | L 115 for L 160 desk | DW775G |
|   |  | L 135 for L 180 desk | DW785G |



● BLACK

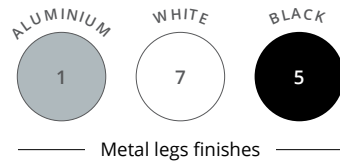

# ASTROLITE



## MULTI-WORKSTATIONS with sliding tops

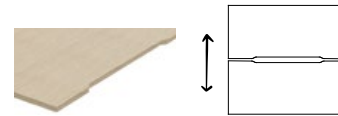

D 143,5 CM

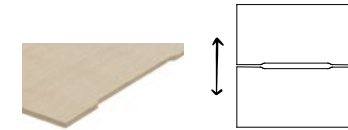

D 163,5 CM

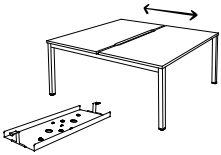
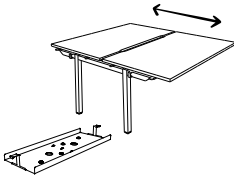
|  | Dim. (cm) | Ref. | Leg finish                 | Top finish                 | Ref. | Leg finish                 | Top finish                 |
|--|-----------|------|----------------------------|----------------------------|------|----------------------------|----------------------------|
| <b>2 back to back desks</b><br><b>Starter unit</b><br>H 72 cm<br>Metal cable tray included  | L 120     | DW22 | + <input type="checkbox"/> | + <input type="checkbox"/> | DW25 | + <input type="checkbox"/> | + <input type="checkbox"/> |
|  | L 140     | DW23 | + <input type="checkbox"/> | + <input type="checkbox"/> | DW26 | + <input type="checkbox"/> | + <input type="checkbox"/> |
|  | L 160     | DW24 | + <input type="checkbox"/> | + <input type="checkbox"/> | DW27 | + <input type="checkbox"/> | + <input type="checkbox"/> |
|  | L 180     | —    | —                          | —                          | DW28 | + <input type="checkbox"/> | + <input type="checkbox"/> |
|  |           |      |                            |                            |      |                            |                            |
| <b>2 back to back desks</b><br><b>Add-on unit</b><br>H 72 cm<br>Metal cable tray included  | L 120     | DW09 | + <input type="checkbox"/> | + <input type="checkbox"/> | DW16 | + <input type="checkbox"/> | + <input type="checkbox"/> |
|  | L 140     | DW10 | + <input type="checkbox"/> | + <input type="checkbox"/> | DW17 | + <input type="checkbox"/> | + <input type="checkbox"/> |
|  | L 160     | DW11 | + <input type="checkbox"/> | + <input type="checkbox"/> | DW18 | + <input type="checkbox"/> | + <input type="checkbox"/> |
|  | L 180     | —    | —                          | —                          | DW19 | + <input type="checkbox"/> | + <input type="checkbox"/> |
|  |           |      |                            |                            |      |                            |                            |

### ► Option

|   | Dim. (cm)            | <input type="radio"/> ALUMINIUM<br>Ref. | <input type="radio"/> WHITE<br>Ref. | <input type="radio"/> BLACK<br>Ref. |
|---|----------------------|---|-------------------------------------|-------------------------------------|
| <b>Vertical cable channel</b><br>Magnetic  | H 61 / L 4,5 / D 1,5 | BY011K                                  | BY017S                              | BY015G                              |

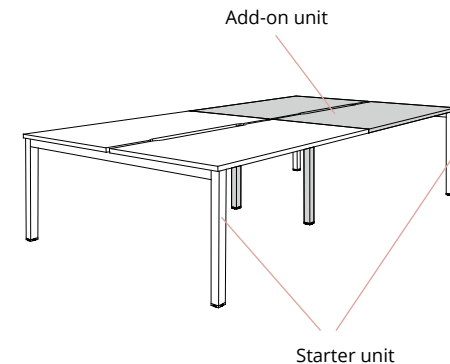

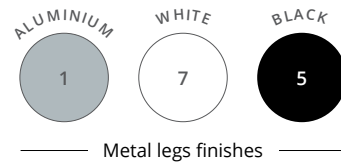

## Round MEETING TABLES

|   | Dim. (cm) | Description                                       | Ref. | Leg finish                 | Top finish                 |
|---|-----------|---|------|----------------------------|----------------------------|
| <b>Round tables</b><br>(seats 3/4)<br>H 74 cm |           | Top fitted with 1 central part drilled cable port | DN98 | + <input type="checkbox"/> | + <input type="checkbox"/> |
|   |           |   | DN33 | + <input type="checkbox"/> | + <input type="checkbox"/> |
|   |           |   | DN34 | + <input type="checkbox"/> | + <input type="checkbox"/> |

## Barrel MEETING TABLE

|   | Dim. (cm)     | Description                                | Ref. | Leg finish                 | Top finish                 |
|---|---------------|--|------|----------------------------|----------------------------|
| <b>Barrel table</b><br>(seats 6)<br>H 72 cm<br>L 140 cm structure | D 100 / L 200 | Top fitted with 2 part drilled cable ports | DN29 | + <input type="checkbox"/> | + <input type="checkbox"/> |

### ► Options

| Description  | ALUMINIUM | WHITE  | BLACK  |
|--|-----------|--------|--------|
|  | Ref.      | Ref.   | Ref.   |
| <b>Cable port covers</b><br>To fit into Ø 80 mm part drilled cable ports. Set of 2   | AX061K    | AX067S | AX065G |
| <b>UK cable port power module</b><br>UK power socket + 1 USB A socket 5v<br>+ 1 USB C socket 5v<br>With a 2 m power supply cable | —         | DX877S | DX875G |
| <b>Vertical cable channel</b><br>Magnetic<br>  | BY011K    | BY017S | BY015G |





Metal legs finishes



Tops MFC finishes

ASTROLITE



## Square MEETING TABLES



WITHOUT TOP ACCESS HATCH

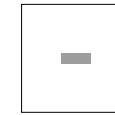

WITH DOUBLE OPENING TOP ACCESS HATCH

|  | Dim. (cm)                    |  | Ref. | Leg finish | Top finish |  | Ref. | Leg finish | Top finish |
|--|------------------------------|--|------|------------|------------|--|------|------------|------------|
| <b>Square tables Starter unit</b><br>H 72 cm | D 143 / L 140<br>(seats 4/6) |  | DF18 | +          | +          |  | DQ46 | +          | +          |
|  | D 163 / L 160<br>(seats 6/8) |  | DF20 | +          | +          |  | DQ47 | +          | +          |
| <b>Square tables Add-on unit</b><br>H 72 cm  | D 143 / L 140<br>(seats 4)   |  | DB93 | +          | +          |  | DQ23 | +          | +          |
|  | D 163 / L 160<br>(seats 4)   |  | DB97 | +          | +          |  | DQ24 | +          | +          |

### ► Options

|   | Description                                      | ALUMINIUM        | WHITE            | BLACK            |
|---|--|------------------|------------------|------------------|
|   |  | Ref.             | Ref.             | Ref.             |
| <b>Technical metal cable trays</b><br>D 16 / H 8 cm<br>Internal H 4 cm                    | <br>L 110 for L 140 desk<br>L 130 for L 160 desk | AZ211K<br>AZ221K | AZ217S<br>AZ227S | AZ215G<br>AZ225G |
| <b>Universal cable duct</b><br>4 rings. To be fixed under the top.<br>Screws not supplied | <br>D 6,5 / H 4,5 / L 9,5                        | DQ101K           | —                | —                |

How to order ? Meeting table with Top Access hatch D 143 / L 140 cm, starter unit, **Black** metal leg, **Clay** top MFC finish = DQ46 +    5    X