

ALTO

Storage solutions

The Alto modular and design storage solutions offer functionality and contemporary design.

With the same aesthetics as the Alto range, the Alto bookcases and credenza complement the layout of workspaces with storage solutions offering practical, functional and smart proximity storage and space partitioning.

With a choice of metal legs (H 32,5 cm) or feet, the Alto storage range offers a choice of heights (75, 105, 146, 176 cm) combined with a 100 cm width shared between an open bookcase and a storage with a hinged door.





**Storage with hinged door H 105 cm
with metal legs**
Black - Nebraska

**2 storages with hinged doors H 146 cm
with screw feet**
Black - White



**Storage with hinged door H 176 cm
with metal legs**
Almond Green legs - White - Bleached Oak



Structure

Storage made of Structurex® melamine-coated panels, 16 mm thick for structure, doors, shelves and 25 mm thick with rounded corners for top and bottom. 2 mm thick shock-proof ABS edging.

Legs

2 base versions to compensate for any unevenness in the floor and allow adjacent units to be aligned :
 - 4 legs H 32,5 cm. Metal finish, cross-section 25 x 25 mm.
 - 5 screw feet H 25 mm from inside the units except for H 143,5 storage.

H 176 / 146 cm Storage with hinged door



Hinged doors

Hinged doors equipped with 100° opening metal hinges with a soft close system.

Hinged doors have a 3-point locking system (1 point for H 75 cm 2 doors storage unit). The lock comes with an interchangeable cylinder and is supplied with 2 keys, one folding.

Storage compartment and hinged door kit positioned (right or left versions) on install.



H 105 / 75 cm Storage with hinged door

Shelves

Shelves made of 16 mm thick Structurex® melamine-coated panels, adjustable in steps of 32 mm on 5 positions. Tool-free shelf installation thanks to pre-drilled cabinet sides.

Internal sizes : D 36,5 x L 56,8 / 38 cm for the L 100 cm bookcase and D 34,5 x L 50,5 / 28 cm for the credenza L 143,5 cm.

Hinged doors

H 75 cm credenza with push-latch system for easy opening of the doors.



Metal design handle
Black or White



CHARACTERISTICS

Smooth finish

WHITE (7) BLACK (5)

Textured finish

ALMOND GREEN (10) OCHRE (11)

Metal legs finishes

BLEACHED OAK (N) NEBRASKA (F) TIMBER (M) YUKON (Y) WHITE (S) BLACK (G*)

Structure, Top / bottom, doors and shelves MFC finishes * for structure only

H 75 / H 105 cm storage with hinged door

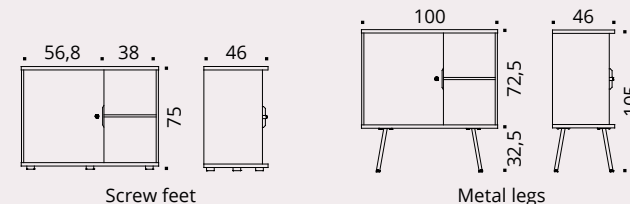

H 146 / 176 cm storage with hinged door

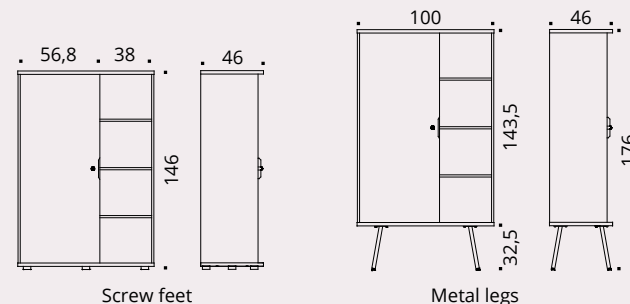

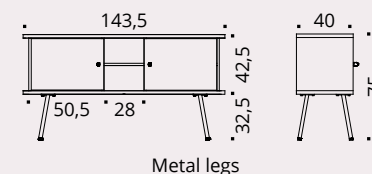

H 75 cm credenza with 2 hinged doors

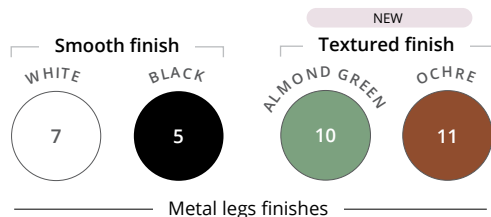

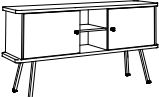
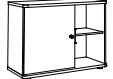
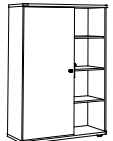

STORAGE with hinged doors

Metal legs		Dim. (cm)	Ref.	Leg finish	Structure finish	Top / bottom + doors + shelves finish
Storage with hinged door H 105 cm 2 Structurex® shelves 		D 46 / L 100	DY30	+ <input type="checkbox"/>	+ <input type="checkbox"/>	+ <input type="checkbox"/>
Storage with hinged door H 176 cm 6 Structurex® shelves 		D 46 / L 100	DY28	+ <input type="checkbox"/>	+ <input type="checkbox"/>	+ <input type="checkbox"/>
Credenza with 2 hinged doors H 75 cm 1 Structurex® shelf 		D 40 / L 143,5	DY31	+ <input type="checkbox"/>	+ <input type="checkbox"/>	+ <input type="checkbox"/>
Screw feet		Dim. (cm)	Ref.	Structure finish	Top / bottom + doors + shelves finish	
Storage with hinged door H 75 cm 1 Structurex® shelf 		D 46 / L 100	DY29	+ <input type="checkbox"/>	+ <input type="checkbox"/>	
Storage with hinged door H 146 cm 3 Structurex® shelves 		D 46 / L 100	DY27	+ <input type="checkbox"/>	+ <input type="checkbox"/>	