

CLASSIF

Metal storage

The highly-robust **Classif** one-piece cabinets offer generous storage space and are fitted with tambour doors for easy access. They can be used to define or delimit collective or coworking spaces. Certified and matching all our furniture ranges, the **Classif** cabinets will fit perfectly in your office space layouts.



CHARACTERISTICS

CLASSIF



One-tone cabinets

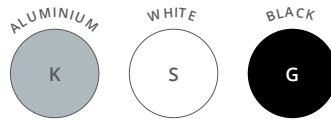

One-tone cabinets - tambour doors plain finishes

Two-tone cabinets



Cabinets bodies finishes



Tambour doors MFC finishes

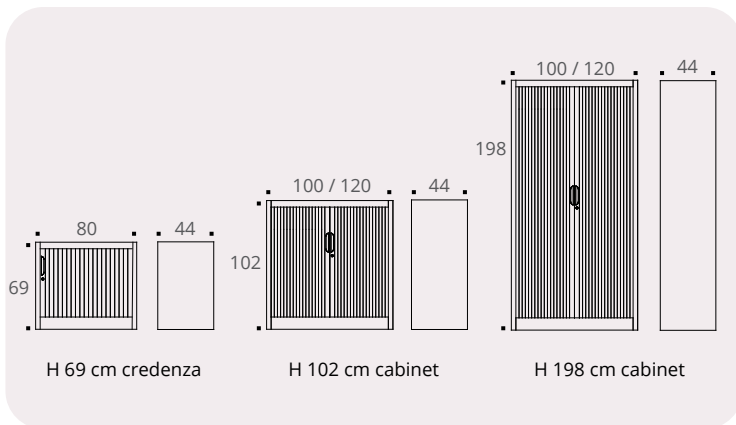

Tops

Optional finishing tops made of 25 mm thick Structurex® panels.

Dimensions

3 heights : H 198 / H 102 / H 69 cm.
 3 widths : L 80 / L 100 / L 120 cm.
 1 depth : D 44 cm.

Shelves

Shelves for lateral filing, in the same finishes as the cabinets, with built-in support pegs, adjustable in steps of 5 cm.
 4 shelf levels in 198 cm high cabinet.
 2 shelf levels in 102 cm high cabinet.
 1 shelf level in 69 cm high credenza.

Tambour

Double strip tambour door made of PVC, fire classification M1.

Wear-resistant polypropylene rails for the PVC tambour doors to slide silently.

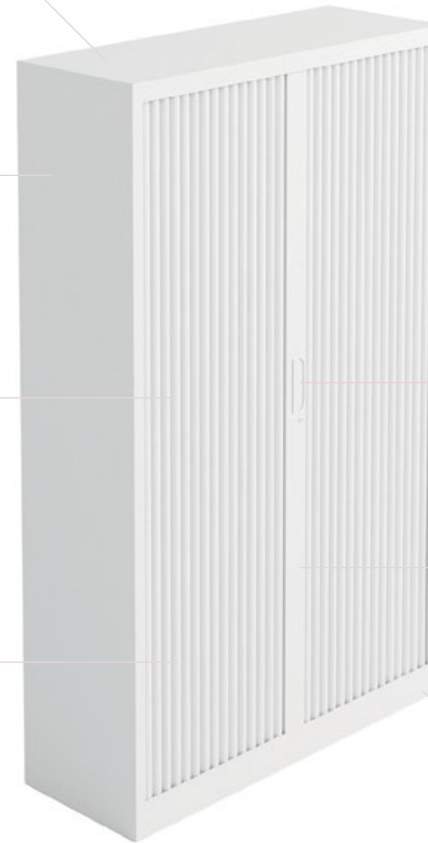

Structure

Highly robust welded one-piece body.
 Structure made of lacquered epoxy steel finish. 1 mm thick top and strip, 0.8 mm thick body and shelves.

Smooth, clean back for use in open space.

Easy opening

Gripping handles for lateral opening.
 Metal lock with 2 keys, including 1 folding.

Terminal strip

Steel terminal strip with anti-intrusion groove.

Adjustment

Adjustable screw feet from inside the cabinet (20 mm range).

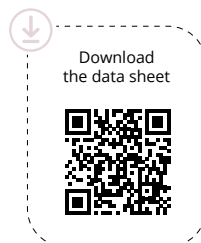

Gripping handles



Anti-intrusion groove



Strip tambour



Shelves for lateral filing

CLASSIF

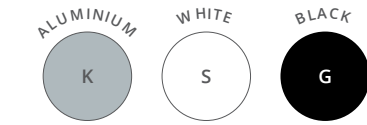

— One-tone cabinets - tambour doors plain finishes —



— Tops MFC finishes —

CABINETS with one-tone tambour doors

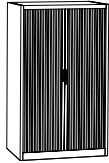
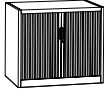
	Description	Dim. (cm)	Ref.	Finish
H 198 cm cabinets D 44 cm 	4 metal Lateral filing shelves 5 Lateral filing hooking levels	L 100	BK353	+ <input type="checkbox"/>
		L 120	BN023	+ <input type="checkbox"/>
H 102 cm cabinets D 44 cm 	2 metal Lateral filing shelves 3 Lateral filing hooking levels	L 100	BK333	+ <input type="checkbox"/>
		L 120	BN013	+ <input type="checkbox"/>

CREDENZA with one-tone tambour doors

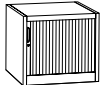
	Description	Dim. (cm)	Ref.	Finish
H 69 cm credenza D 44 cm 	1 horizontal opening tambour door 1 metal Lateral filing shelf	L 80	BM513	+ <input type="checkbox"/>

► Options

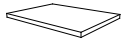
	Dim. (cm)	Ref.	Finish
Structurex® tops thickness 25 mm 	L 80 / D 44	BM523	+ <input type="checkbox"/>
	L 100 / D 44	BM493	+ <input type="checkbox"/>
	L 120 / D 44	BM503	+ <input type="checkbox"/>



How to order ? H 69 / L 80 cm credenza, **White** finish and **Clay** L 80 cm top MFC finish = BM513 + **S** and BM523 + **X**

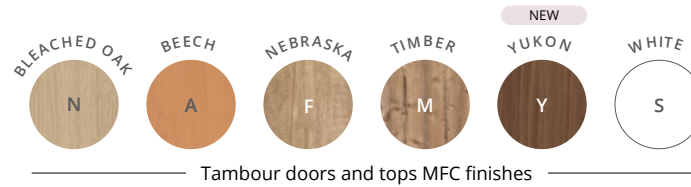
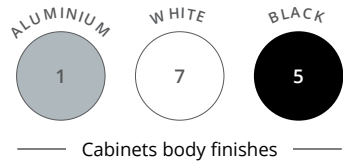

CLASSIF

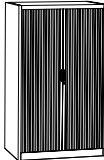

CABINETS with two-tone tambour doors

	Description	Dim. (cm)	Ref.	Body finish	Tambour finish
H 198 cm cabinets D 44 cm 	4 metal Lateral filing shelves 5 Lateral filing hooking levels	L 100	BK35	+ []	+ []
		L 120	BN02	+ []	+ []
H 102 cm cabinets D 44 cm 	2 metal Lateral filing shelves 3 Lateral filing hooking levels	L 100	BK33	+ []	+ []
		L 120	BN01	+ []	+ []

► **Options**

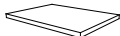
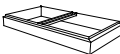
	Dim. (cm)	Ref.	Finish
Structurex® tops thickness 25 mm 	L 100 / D 44	BM493	+ []
	L 120 / D 44	BM503	+ []
Roll out filing frame 	L 100	BM574G	Black
	L 120	BM584G	Black



STORAGE