

QUIÉTUDE

Melamine-coated
storage units

Quiétude is a universal storage solution.

Modular and available in a wide selection of colours, **Quiétude** cupboards and bookcases can be combined with all operator and management desks. Used mainly to store documents, **Quiétude** bookcases can also be used to partition workspaces.



Combinaison of storage units with alcove H 201 cm
 White - Nebraska alcove - Aluminium classic handles



2 cupboards + 1 column H 104 cm
 Nebraska - Black column - Black design handles

STORAGE

QUIÉTUDE

2 cupboards H 136 cm, hinged doors with fabric back panel
White - Peach - White design handles - Ochre back panel fabric



2 cupboards H 201 cm, hinged doors
Bleached oak - White design handles

CHARACTERISTICS



— Storage, shelves and tops MFC finishes —

QUIÉTUDE



Structure

Structure made of 16 mm thick Structurex® melamine-coated panels, top made of 25 mm thick Structurex® melamine-coated panels. 2 mm thick shock-proof ABS edging.

Shelves

Shelves made of 25 mm thick Structurex® melamine-coated panels or 0,6 mm thick metal in aluminium lacquered epoxy finish for lateral filing, depending on version.

Storage sides part drilled for tool-free installation of the shelves.

Shelves adjustable in steps of 32 mm, internal depth 36 cm.

Adjustment

Adjustable feet to compensate for any unevenness in the floor and allow adjacent units to be aligned.

Feet are adjustable from inside the units.

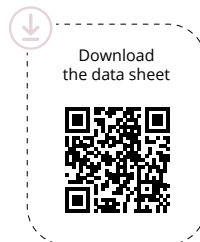

Hinged doors

Doors made of 16 mm thick Structurex® melamine-coated panels. 2 mm thick shock-proof ABS edging.

Doors equipped with 100° opening metal hinges and soft close system.

Locking

Hinged doors have a 3-point locking system. The lock comes with an interchangeable cylinder and is supplied with two keys, one folding.



H 201 cm cupboard

H 136 cm cupboard

H 104 cm cupboard

H 72 cm cupboard



Roll-out filing frame

Optional roll-out filing frame. Recommendations : 1 frame per 72 cm high storage unit; 2 frames per 104 cm high and 136 cm high storage unit and 3 frames per 201 cm high storage unit.



C Classic handle



D Design handle

H 72 cm storage

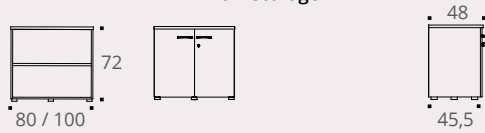

H 104 cm storage

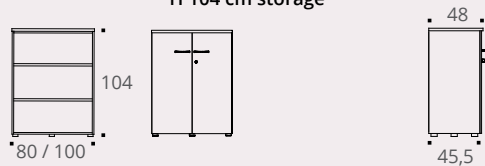

H 136 cm storage

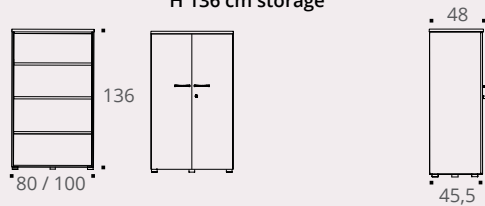

H 201 cm storage - (H 203 cm with optional finishing top)

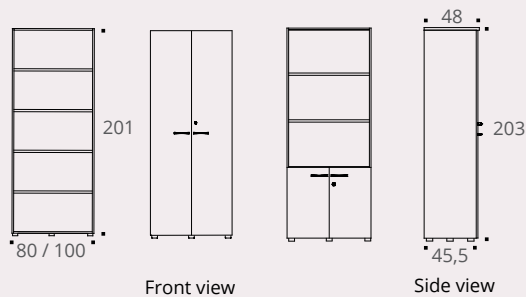



Storage and tops MFC finishes

Open BOOKCASES

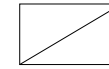

L 80 CM

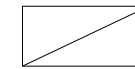

L 100 CM

		Description	Ref.	Finish	Ref.	Finish
H 72 cm storage D 48 cm Finishing top included		Open - 1 Structurex® shelf	BP503	+ <input type="checkbox"/>	BU323	+ <input type="checkbox"/>
		<hr/>				
H 104 cm storage D 48 cm Finishing top included		Open - 2 Structurex® shelves	BU223	+ <input type="checkbox"/>	BU343	+ <input type="checkbox"/>
		Open - 2 metal Lateral filing shelves	BU233	+ <input type="checkbox"/>	BU353	+ <input type="checkbox"/>
H 136 cm storage D 48 cm Finishing top included		Open - 3 Structurex® shelves	BU263	+ <input type="checkbox"/>	BU383	+ <input type="checkbox"/>
		Open - 3 metal Lateral filing shelves	BU273	+ <input type="checkbox"/>	BU393	+ <input type="checkbox"/>
H 201 cm storage D 45,5 cm Finishing top available on option		Open - 4 Structurex® shelves	BH813	+ <input type="checkbox"/>	BH823	+ <input type="checkbox"/>
		Open - 4 metal Lateral filing shelves	BH833	+ <input type="checkbox"/>	BH843	+ <input type="checkbox"/>

► Option - for H 201 cm storage

		Description	Ref.	Finish
Finishing top* For H 201 storage		L 80 cm	BH713	+ <input type="checkbox"/>
		L 100 cm	BH723	+ <input type="checkbox"/>



* Non structural. For an aesthetic finish

How to order ? H 72 / L 80 cm bookcase, 1 Structurex® shelf, with top, **Nebraska** MFC finish = BP503 + F

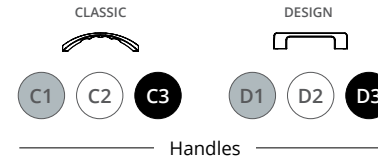
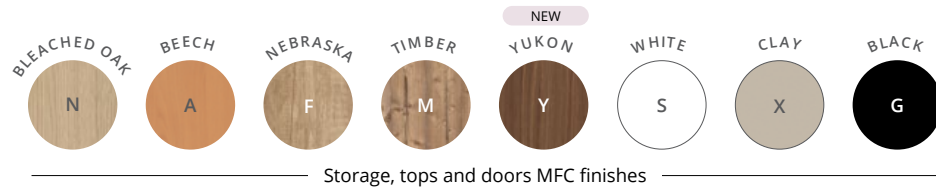

QUIÉTUDE



Hinged doors CUPBOARDS

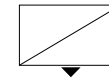

L 80 CM

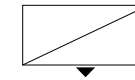

L 100 CM

	Description	Ref.	Storage finish	Handles finish	Ref.	Storage finish	Handles finish	
H 72 cm storage D 48 cm Finishing top included		2 hinged doors - 1 Structurex® shelf <i>For 1 level of binders</i>	BP513	+ <input type="checkbox"/>	+ <input type="checkbox"/>	BU333	+ <input type="checkbox"/>	+ <input type="checkbox"/>
		2 hinged doors - 2 Structurex® shelves	BU243	+ <input type="checkbox"/>	+ <input type="checkbox"/>	BU363	+ <input type="checkbox"/>	+ <input type="checkbox"/>
H 104 cm storage D 48 cm Finishing top included		2 hinged doors - 2 metal Lateral filing shelves <i>For 2 levels of binders</i>	BU253	+ <input type="checkbox"/>	+ <input type="checkbox"/>	BU373	+ <input type="checkbox"/>	+ <input type="checkbox"/>
		2 hinged doors - 3 Structurex® shelves	BU283	+ <input type="checkbox"/>	+ <input type="checkbox"/>	BU403	+ <input type="checkbox"/>	+ <input type="checkbox"/>
H 136 cm storage D 48 cm Finishing top included		2 hinged doors - 3 metal Lateral filing shelves <i>For 3 levels of binders</i>	BU293	+ <input type="checkbox"/>	+ <input type="checkbox"/>	BU413	+ <input type="checkbox"/>	+ <input type="checkbox"/>
		2 hinged doors - 4 Structurex® shelves	BH973	+ <input type="checkbox"/>	+ <input type="checkbox"/>	BH983	+ <input type="checkbox"/>	+ <input type="checkbox"/>
H 201 cm storage D 48 cm Finishing top available on option		2 hinged doors - 4 metal Lateral filing shelves <i>For 5 levels of binders</i>	BH993	+ <input type="checkbox"/>	+ <input type="checkbox"/>	BJ003	+ <input type="checkbox"/>	+ <input type="checkbox"/>
		H 201 cm bookcase D 48 cm Finishing top available on option		Open upper part 2 low hinged doors - 4 Structurex® shelves	BJ013	+ <input type="checkbox"/>	+ <input type="checkbox"/>	BJ023

► Options - for storage combinations

	Description	L 80 CM		L 100 CM		
		Ref.	Finish	Ref.	Finish	
Optional shelf		Structurex® shelf	BJ533	+ <input type="checkbox"/>	BJ543	+ <input type="checkbox"/>
		Metal aluminium Lateral filing shelf	AE301K	—	AE021K	—
Roll out filing frame		Black roll out filing frame <i>To be fitted in the lower part of the storage unit</i>	AE294G	—	AE014G	—
		Anti-tilt weight (common 2 widths)	AE991K	—	—	—

How to order ? H 201 / L 100 cm bookcase, 2 low hinged doors + 4 Structurex® shelves, with top, **Nebraska** MFC finish, **Black** handles type **D** = BJ023 + **F** **D3**



Structures, shelves and tops MFC finishes

How to create your own storage unit ?

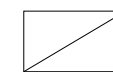
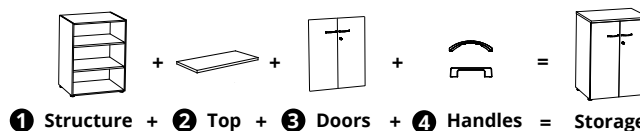

L 80 CM

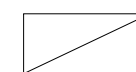

L 100 CM

STORAGE combinations

Select structures, tops, doors and handles

1 Structures		Description	Ref.	Finish	Ref.	Finish
H 69,5 cm storage D 48 cm <i>Finish top 2 required</i>		Open - 1 Structurex® shelf	BH693	+ <input type="checkbox"/>	BH703	+ <input type="checkbox"/>
		Open - 2 Structurex® shelves	BH733	+ <input type="checkbox"/>	BH743	+ <input type="checkbox"/>
		Open - 2 metal Lateral filing shelves	BH753	+ <input type="checkbox"/>	BH763	+ <input type="checkbox"/>
H 101,5 cm storage D 48 cm <i>Finish top 2 required</i>		Open - 3 Structurex® shelves	BH773	+ <input type="checkbox"/>	BH783	+ <input type="checkbox"/>
		Open - 3 metal Lateral filing shelves	BH793	+ <input type="checkbox"/>	BH803	+ <input type="checkbox"/>
H 133,5 cm storage D 48 cm <i>Finish top 2 required</i>		Open - 4 Structurex® shelves	BH813	+ <input type="checkbox"/>	BH823	+ <input type="checkbox"/>
		Open - 4 metal Lateral filing shelves	BH833	+ <input type="checkbox"/>	BH843	+ <input type="checkbox"/>
H 201 cm storage D 45,5 cm <i>Finish top not mandatory</i>		Open - for low hinged doors bookcase	DR163	+ <input type="checkbox"/>	DR173	+ <input type="checkbox"/>
2 Tops		Description	Ref.	Finish	Ref.	Finish
Common finishing tops <i>Not available in L 300 cm version</i>		L 80 or L 100 cm. For 1 storage unit L 80 or L 100 cm	BH713	+ <input type="checkbox"/>	BH723	+ <input type="checkbox"/>
		L 160 or L 200 cm. For 2 storage units L 80 or L 100 cm each	BJ083	+ <input type="checkbox"/>	BJ103	+ <input type="checkbox"/>
		L 240 cm. For 3 storage units L 80 cm each	BJ093	+ <input type="checkbox"/>	—	—

How to order ? H 201 / L 100 cm storage, 4 metal Lateral filing shelves, Timber MFC finish = BH843 + M

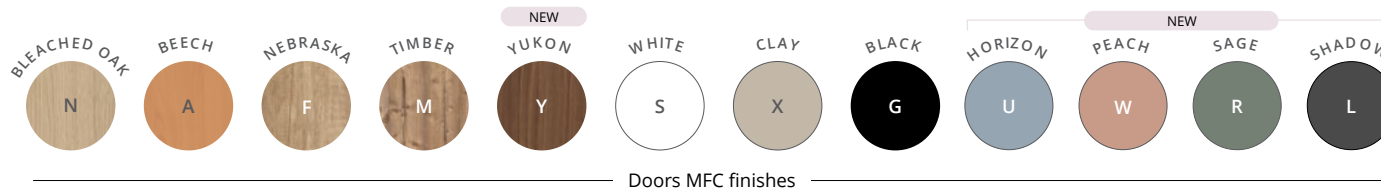

STORAGE combinations
Select structures, tops, doors and handles



L 80 CM



L 100 CM

3 Doors

2 Structurex® hinged doors
For open storage
Without handles

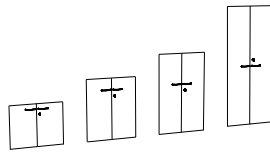

Description	Ref.	Doors finish	Ref.	Doors finish
For H 72 cm storage and H 201 cm bookcase. Set of 2 doors	EH783	+ <input type="checkbox"/>	EH823	+ <input type="checkbox"/>
For H 104 cm storage. Set of 2 doors	EH793	+ <input type="checkbox"/>	EH833	+ <input type="checkbox"/>
For H 136 cm storage. Set of 2 doors	EH803	+ <input type="checkbox"/>	EH843	+ <input type="checkbox"/>
For H 201 cm storage. Set of 2 doors	EH813	+ <input type="checkbox"/>	EH853	+ <input type="checkbox"/>



CLASSIC



DESIGN

Handles

CLASSIC

Classic handle finishes

DESIGN

Design handle finishes

4 Handles

Set of 2 handles

Description	Ref.	Finish	Ref.	Finish
Metal handle	BA00	+ <input type="checkbox"/>	DX21	+ <input type="checkbox"/>



Fabric back

Fabric back panel
To be attached to the back of the storage units

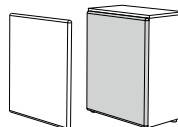

Description	Ref.	Fabric finish	Ref.	Fabric finish
For H 104 cm storage	EH103	+ <input type="checkbox"/>	EH123	+ <input type="checkbox"/>
For H 136 cm storage	EH113	+ <input type="checkbox"/>	EH133	+ <input type="checkbox"/>



How to create your own storage unit with alcove ?

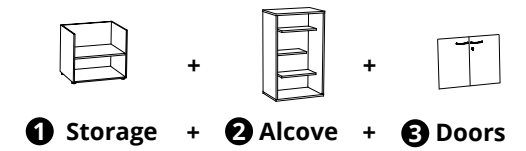

TECHNICAL DESCRIPTION

- Alcove structure and shelves made of 25 mm thick Structorex® melamine-coated panels. 2 mm thick shock-proof ABS edging.
- Alcove dimensions : H 131 / D 52 cm. 2 widths : 80 and 100 cm.
- **The alcove must be placed on a 69,5 cm storage unit (open or with hinged doors)**
- Equipped with 3 fixed shelves L 58 x D 28 cm.
- The top shelf can be removed to install a TV screen (maximum 32 inch for 80 cm alcove / 40 inch for 100 cm alcove).

Storage unit with alcove

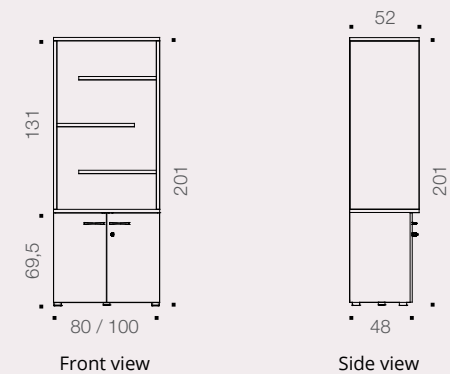

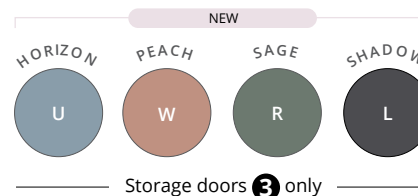
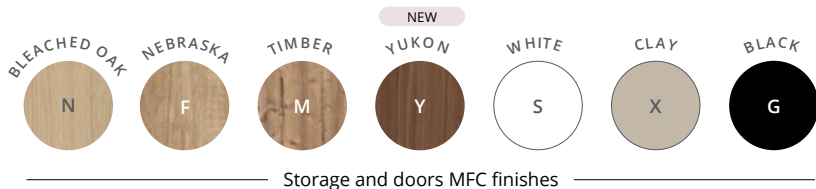

QUIÉTUDE



STORAGE UNIT WITH ALCOVE combinations

Select storage units, alcoves, doors and handles

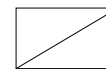

L 80 CM

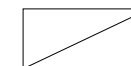

L 100 CM

1 Structures	Description	Ref.	Finish	Ref.	Finish
H 69,5 cm storage D 48 cm 	Open - 1 Structurex® shelf	BH693	+ <input type="checkbox"/>	BH703	+ <input type="checkbox"/>
	Open - 4 Structurex® shelves	BH813	+ <input type="checkbox"/>	BH823	+ <input type="checkbox"/>
H 201 cm storage D 45,5 cm 	Open - for bookcase with low hinged doors	DR163	+ <input type="checkbox"/>	DR173	+ <input type="checkbox"/>

2 Alcove	Description	Ref.	Structure finish	Shelves finish	Ref.	Structure finish	Shelves finish
Alcove with shelves D 52 / H 131 cm Can be positioned only on the H 69,5 cm storage unit 	Equipped with 3 fixed Structurex® shelves	DZ07	+ <input type="checkbox"/>	+ <input type="checkbox"/>	DZ08	+ <input type="checkbox"/>	+ <input type="checkbox"/>
	Horizontal wood grain for the wood finish structures						

Not available in plain wood finish

3 Doors	Description	L 80 CM		L 100 CM	
		Ref.	Doors finish	Ref.	Doors finish
2 Structurex® hinged doors For open storage Without handles 	For H 72 cm storage and H 201 cm bookcase. Set of 2 doors.	EH783	+ <input type="checkbox"/>	EH823	+ <input type="checkbox"/>
	For H 201 cm storage. Set of 2 doors.	EH813	+ <input type="checkbox"/>	EH853	+ <input type="checkbox"/>
			CLASSIC	DESIGN	

4 Handles	Description	Ref.	Finish	Ref.	Finish
Set of 2 handles	Metal handle	BA00	+ <input type="checkbox"/>	DX21	+ <input type="checkbox"/>

Handles

CLASSIC

ALUMINIUM (1K) WHITE (7S) BLACK (5G)

Classic handle finishes

DESIGN

ALUMINIUM (1K) WHITE (7S) BLACK (5G)

BLUE (13U) OCHRE (11W) SAGE (12R) SHADOW (2L)

Design handle finishes

How to order ? H 69,5 / L 80 cm hinged doors storage with alcove, **White** structure, **Bleached Oak** hinged doors MFC finish, **White** alcove, **White Design** handle = BH693 + S , DZ07 + S S , EH783 + N and DX21 + 7S

QUIÉTUDE

2 columns H 201 cm 4 compartments

White



2 low cupboards + 1 column H 72 cm
White - Black column - Black classic handles



3 columns H 101,5 cm 3 compartments
Clay

STORAGE



COLUMN STORAGE

Columns only available in plain finishes



Columns
D 32,5 / L 40 cm
Fixed shelves

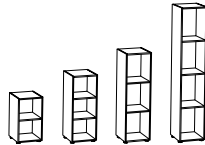

Description	Ref.	Finish
H 69,5 cm - with 2 compartments H 31,8 cm	AW713	+ <input type="checkbox"/>
H 101,5 cm - with 3 compartments (2 compartments H 31,8 cm + 1 central niche H 29,3 cm)	AW723	+ <input type="checkbox"/>
H 133,5 cm - with 3 compartments (2 compartments H 41,5 cm + 1 central niche H 41,8 cm)	AW733	+ <input type="checkbox"/>
H 201 cm - with 4 compartments H 47,6 cm	AW743	+ <input type="checkbox"/>



STORAGE UNIT COMBINATIONS

with columns, shared top and Structurex® shelves

Columns only available in plain finishes

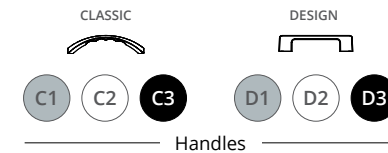

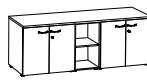
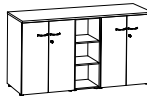
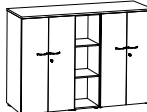
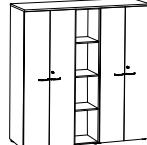
	Description	Ref.	Column finish	Cupboards finish	Handles finish
2 low cupboards + 1 column H 72 cm D 48 / H 72 cm		L 200	BU42	+ <input type="checkbox"/>	+ <input type="checkbox"/>
	L 240	BU43	+ <input type="checkbox"/>	+ <input type="checkbox"/>	+ <input type="checkbox"/>
<i>Each H 72 cm storage unit with hinged doors includes 1 Structurex® shelf</i>					
2 cupboards + 1 column H 104 cm D 48 / H 104 cm		L 200	BU44	+ <input type="checkbox"/>	+ <input type="checkbox"/>
	L 240	BU45	+ <input type="checkbox"/>	+ <input type="checkbox"/>	+ <input type="checkbox"/>
<i>Each H 104 cm storage unit with hinged doors includes 2 Structurex® shelves</i>					
2 cupboards + 1 column H 136 cm D 48 / H 136 cm		L 200	BU46	+ <input type="checkbox"/>	+ <input type="checkbox"/>
	L 240	BU47	+ <input type="checkbox"/>	+ <input type="checkbox"/>	+ <input type="checkbox"/>
<i>Each H 136 cm storage unit with hinged doors includes 3 Structurex® shelves</i>					
2 high cupboards + 1 column H 203 cm D 48 / H 203 cm		L 200	BU48	+ <input type="checkbox"/>	+ <input type="checkbox"/>
	L 240	BU49	+ <input type="checkbox"/>	+ <input type="checkbox"/>	+ <input type="checkbox"/>
<i>Each H 203 cm storage unit with hinged doors includes 4 Structurex® shelves</i>					

How to order ? H 101,5 cm column, with 3 compartments, Clay column plain finish = AW723 + X